

WEED EATER

® Trademark

Instruction Manual Manual de Instrucciones Manuel d'Instructions

**BV200 / BV1650 / BV1800
BV1850 / BV2000
LE Series**

**IMPORTANT MANUAL - Do not throw away
MANUAL IMPORTANTE - No lo descarte
MANUEL IMPORTANT - À Conserver**



WARNING:

Read and follow all Safety Rules and Operating Instructions before using this product. Failure to do so can result in serious injury.

ADVERTENCIA:

Lea el manual de instrucciones y siga todas las advertencias e instrucciones de seguridad. El no hacerlo puede resultar en lesiones graves.

AVERTISSEMENT:

Veuillez lire le manuel d'instructions et bien respecter tous les avertissements et toutes les instructions de sécurité. Tout défaut de le faire pourrait entraîner des blessures graves.

Electrolux Home Products, Inc.
250 Bobby Jones Expressway
Augusta, GA 30907

 **From the Electrolux Group.** *The world's No.1 choice.*
KITCHEN, CLEANING AND OUTDOOR APPLIANCES COMBINED

Copyright ©2002 Electrolux Home Products, Inc.

530086692

4/26/02

ENGLISH

ESPAÑOL

FRANÇAIS

SAFETY RULES

⚠ WARNING: Failure to follow all Safety Rules and Precautions can result in serious injury.

KNOW YOUR UNIT

- Read your instruction manual carefully until you completely understand and can follow all warnings and safety rules before operating the unit.
- Restrict unit to users who understand and will follow all warnings and safety rules in this manual.

⚠ WARNING: Inspect area before starting unit. Remove all debris and hard objects such as rocks, glass, wire, etc. that can ricochet, be thrown, or otherwise cause injury or damage during operation.

Use your unit as a blower for:

- Sweeping debris or grass clippings from driveways, sidewalks, patios, etc.
- Blowing grass clippings, straw, or leaves into piles, around joints, or between bricks.

Use your unit as a vacuum for:

- Picking up dry material such as leaves, grass, small twigs, and bits of paper.
- For best results during vacuum use, operate your unit at high speed.
- Move slowly back and forth over the material as you vacuum. Avoid forcing the unit into a pile of debris as this can clog the unit.
- Keep the vacuum tube about an inch above the ground for best results.

PLAN AHEAD

- Always wear eye protection when operating, servicing, or performing maintenance on unit. Wearing eye protection will help to prevent rocks or debris from being blown or ricocheting into eyes and face which can result in blindness and/or serious injury. Eye protection should be marked Z87.
- Always wear foot protection. Do not go barefoot or wear sandals.
- Always wear respirator or face mask when working with unit in dusty environments.
- Secure hair above shoulder length. Secure or remove jewelry, loose clothing, or clothing with loosely hanging straps, ties, tassels, etc. They can be caught in moving parts.
- Do not operate unit when you are tired, ill, upset, or if you are under the influence of alcohol, drugs, or medication.
- Keep children, bystanders, and animals away from work area a minimum of 30 feet (10 meters) when starting or operating unit. Do not point the blower nozzle in the direction of people or pets.

HANDLE FUEL WITH CAUTION, IT IS HIGHLY FLAMMABLE

- Eliminate all sources of sparks or flame (including smoking, open flames, or work that

can cause sparks) in the areas where fuel is mixed, poured, or stored.

- Mix and pour fuel in an outdoor area; store fuel in a cool, dry, well ventilated place; use an approved, marked container for all fuel purposes.
- Do not smoke while handling fuel or while operating the unit.
- Make sure the unit is properly assembled and in good operating condition.
- Do not fill fuel tank while engine is hot or running.
- Avoid spilling fuel or oil. Wipe up fuel spills before starting engine.
- Move at least 10 feet (3 meters) away from fuel and fueling site before starting engine.
- Always store gasoline in a container approved for flammable liquids.

OPERATE YOUR UNIT SAFELY

⚠ WARNING: Stop the engine before opening the vacuum inlet door. The engine must be stopped and the impeller blades no longer turning to avoid serious injury from the rotating blades.

- Inspect unit before each use for worn, loose, missing, or damaged parts. Do not use until unit is in proper working order.
- Keep outside surfaces free of oil and fuel.
- Never start or run engine inside a closed room, building or other unventilated area. Breathing exhaust fumes can kill.
- To avoid static electricity shock, do not wear rubber gloves or any other insulated gloves while operating unit.
- Do not set unit on any surface except a clean, hard area while engine is running. Debris such as gravel, sand, dust, grass, etc. could be picked up by the air intake and thrown out through discharge opening, damaging unit, property, or causing serious injury to bystanders or operator.
- Avoid dangerous environments. Do not use in unventilated areas or where explosive vapors or carbon monoxide build up could be present.
- Do not overreach or use from unstable surfaces such as ladders, trees, steep slopes, rooftops, etc. Keep firm footing and balance at all times.
- Never place objects inside the blower tubes; always direct the blowing debris away from people, animals, glass, and solid objects such as trees, automobiles, walls, etc. The force of air can cause rocks, dirt, or sticks to be thrown or to ricochet which can hurt people or animals, break glass, or cause other damage.
- Never run unit without the proper equipment attached. When using your unit as a blower, always install blower tubes. When using your unit as a vacuum, always install vacuum tubes and vacuum bag assembly. Make sure vacuum bag assembly is completely zipped.
- Check air intake opening, blower tubes, vacuum tubes, and elbow tube frequently, always with engine stopped and spark plug

disconnected. Keep vents and discharge tubes free of debris which can accumulate and restrict proper air flow.

- Never place any object in the air intake opening as this could restrict proper air flow and cause damage to the unit.
- Never use for spreading chemicals, fertilizers, or other substances which may contain toxic materials.
- To avoid spreading fire, do not use near leaf or brush fires, fireplaces, barbecue pits, ashtrays, etc.
- Use only for jobs explained in this manual.

MAINTAIN YOUR UNIT PROPERLY

- Have all maintenance other than the recommended procedures described in the instruction manual performed by an authorized service dealer.
- Disconnect spark plug before performing maintenance except for carburetor adjustments.
- Use only recommended **Weed Eater®** replacement parts; use of any other parts may void your warranty and cause damage to your unit.
- Empty fuel tank before storing the unit. Use up fuel left in carburetor by starting engine and letting it run until it stops.
- Do not use any accessory or attachment other than those recommended by manufacturer for use with your unit.
- Do not store the unit or fuel in a closed area where fuel vapors can reach sparks or an open flame from hot water heaters, electric motors or switches, furnaces, etc.
- Store in a dry area out of reach of children.

SPECIAL NOTICE: Exposure to vibrations through prolonged use of gasoline powered hand tools could cause blood vessel or nerve damage in the fingers, hands, and joints of people prone to circulation disorders or abnormal swelling. Prolonged use in cold weather has been linked to blood vessel damage in otherwise healthy people. If symptoms occur such as numbness, pain, loss of strength, change in skin color or texture, or loss of feeling in the fingers, hands, or joints, discontinue the use of this tool and seek medical attention. An antivibration system does not guarantee the avoidance of these problems. Users who operate power tools on a continual and regular basis must monitor closely their physical condition and the condition of this tool.

SPECIAL NOTICE: This unit is equipped with a temperature limiting muffler and spark arresting screen which meets the requirements of California Codes 4442 and 4443. All U.S. forest land and the states of California, Idaho, Maine, Minnesota, New Jersey, Oregon, and Washington require by law that many internal combustion engines be equipped with a spark arresting screen. If you operate in a locale where such regulations exist, you are legally responsible for maintaining the operating condition of these parts. Failure to do so is a violation of the law. Refer to the

MAINTENANCE section for information on maintenance of the muffler and spark arresting screen.

ASSEMBLY

WARNING: Stop engine and be sure the impeller blades have stopped turning before opening the vacuum inlet door or attempting to insert or remove the vacuum or blower tubes. The rotating blades can cause serious injury. Always disconnect the spark plug before performing maintenance or accessing movable parts.

WARNING: If you receive your unit assembled, check each step to insure your unit is properly assembled and all fasteners are secure. Follow all safety information in the manual and on the unit.

- A standard screwdriver is required for assembly.

BLOWER TUBE ASSEMBLY

- Align the rib on the blower tube with the groove in the blower outlet; slide the tube into place.

NOTE: Tube clamp must be loose enough to allow blower tube to be inserted in blower outlet. Loosen tube clamp by turning knob counterclockwise.

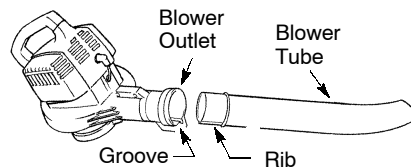

- Tighten the tube clamp by turning the knob clockwise.
- To remove the tube, turn the knob counterclockwise to loosen clamp; remove tube.

VACUUM BAG ASSEMBLY

- Open the zipper on the vacuum bag and insert the elbow tube.
- Push the small end of the elbow tube through the small opening in the bag.

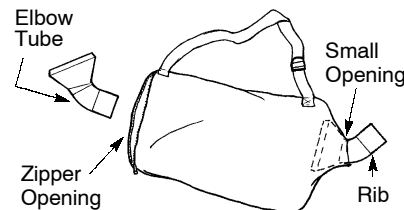

NOTE: Make sure edge of the small opening is flush against the flared area of the elbow tube, and the rib on the elbow tube is on the bottom.

- Close the zipper on the bag. Make sure the zipper is closed completely.
- Remove blower tube from engine.

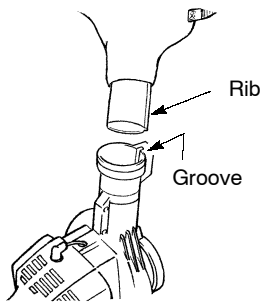

- Insert the elbow tube into the blower outlet. Make sure elbow tube rib is aligned with the blower outlet groove.
- Turn clamp knob clockwise to tighten.
- Secure the ends of the shoulder strap by routing the strap through the buckle as shown.

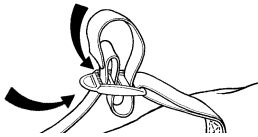

VACUUM TUBE ASSEMBLY

WARNING: Stop engine and be sure the impeller blades have stopped turning before opening the vacuum inlet door or attempting to insert or remove the vacuum or blower tubes. The rotating blades can cause serious injury.

- Align the lower vacuum tube as shown. Push lower vacuum tube into upper vacuum tube.

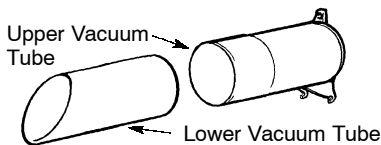

- Insert a screwdriver into the latch area on the vacuum inlet cover.

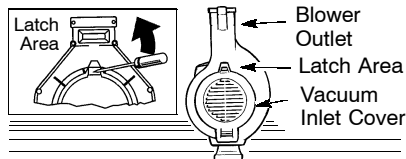

- Gently tilt the handle of the screwdriver toward the back of the unit while pulling up on the vacuum inlet cover with your other hand.
- Hold the vacuum inlet cover open until upper vacuum tube is installed.

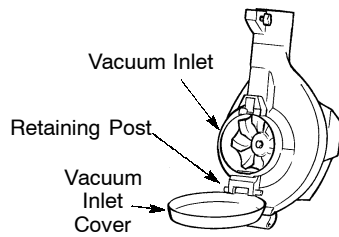

- Place the hooks on the vacuum tube on the retaining posts; pivot tube into position. Secure vacuum tube by turning the knob clockwise until tight.

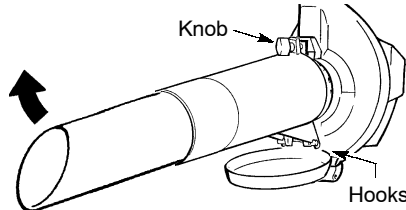

- When converting back to the blower feature, make sure latch on the vacuum inlet cover is securely fastened.

USING YOUR UNIT

WARNING: You MUST make sure the tubes are secure before using the unit.

OPERATING POSITION

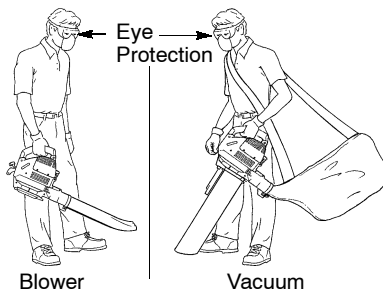

OPERATING TIPS

- While vacuuming or blowing debris, hold the unit with the muffler side facing away from your body and clothes (see illustration above).
- To reduce the risk of hearing loss associated with sound level(s), hearing protection is required.
- To reduce the risk of injury associated with contacting rotating parts, stop the engine before installing or removing attachments. Do not operate without guard(s) in place.
- Operate power equipment only at reasonable hours—not early in the morning or late at night when people might be disturbed. Comply with times listed in local ordinances. Usual recommendations are 9:00 a.m. to 5:00 p.m., Monday through Saturday.

- To reduce noise levels, limit the number of pieces of equipment used at any one time.
- To reduce noise levels, operate power blowers at the lowest possible throttle speed to do the job.
- Use rakes and brooms to loosen debris before blowing.
- In dusty conditions, slightly dampen surfaces or use a mister attachment when water is available.
- Conserve water by using power blowers instead of hoses for many lawn and garden applications, including areas such as gutters, screens, patios, grills, porches, and gardens.
- Watch out for children, pets, open windows, or freshly washed cars. Blow debris away safely.
- Use the full blower nozzle extension so the air stream can work close to the ground.
- After using blowers and other equipment, CLEAN UP! Dispose of debris in trash receptacles.

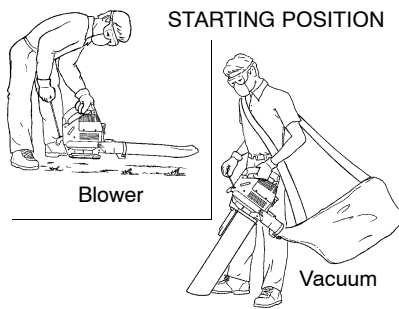

WARNING: When starting engine, hold the unit as illustrated. Do not set unit on any surface except a clean, hard area when starting engine or while engine is running. Debris such as gravel, sand, dust, grass, etc. could be picked up by the air intake and thrown out through the discharge opening, damaging the unit or property, or causing serious injury to bystanders or the operator.

STARTING A COLD ENGINE (or a warm engine after running out of fuel)

- Move throttle lever to the position.
- Move choke lever to the FULL CHOKE position.
- Slowly press the primer button 8 times.

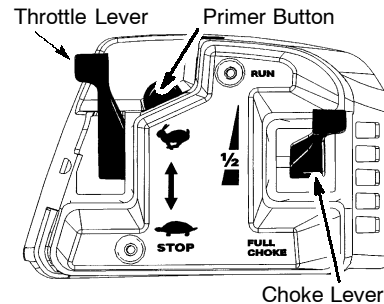

- Pull starter rope sharply until engine attempts to run, but no more than 5 pulls (below 30° F, 8 pulls).

NOTE: If engine attempts to start before the 5th pull, go to next step immediately.

- Move the choke lever to the HALF CHOKE position.
- Pull the starter rope sharply until the engine runs, but no more than 5 pulls (below 30° F, 10 pulls). Run engine for 5 seconds, then move choke lever to the RUN position.
- Allow the unit to run for 30 more seconds at the RUN position before moving the throttle lever to position.

If engine has not started after 5 pulls (at HALF CHOKE), repeat STARTING A COLD ENGINE procedure. If engine still does not start, proceed to STARTING A FLOODED ENGINE.

STARTING A WARM ENGINE

- Move throttle lever to the position.
- Pull starter rope sharply until engine runs, but no more than 5 pulls.

FUELING

WARNING: Remove fuel cap slowly when refueling.

This engine is certified to operate on unleaded gasoline. Gasoline must be mixed with a good quality synthetic 2-cycle air-cooled engine oil designed to be mixed at a ratio of 40:1. Poulan/Weed Eater brand synthetic oil is recommended. (A 40:1 ratio is obtained by mixing 3.2 ounces of oil with 1 gallon of unleaded gasoline). When mixing fuel follow the instructions printed on the container. Always read and follow the safety rules under HANDLE FUEL WITH CAUTION.

IMPORTANT

Experience indicates that alcohol blended fuels (called gasohol or using ethanol or methanol) can attract moisture which leads to separation and formation of acids during storage. Acidic gas can damage the fuel system of an engine while in storage. To avoid engine problems, empty the fuel system before storage for 30 days or longer. Drain the gas tank, start the engine and let it run until the fuel lines and carburetor are empty. Use fresh fuel next season.

STARTING

TO STOP THE ENGINE

- To stop the engine, move the throttle lever to the STOP position.

BEFORE STARTING THE ENGINE

- Fuel engine. Move at least 10 feet (3 meters) away from the fueling site.
- Hold the unit in the starting position as shown. Make sure the blower end is directed away from people, animals, glass, and solid objects.

NOTE: If engine has not started, pull starter rope 5 more pulls. If engine still does not run, it is probably flooded.

STARTING A FLOODED ENGINE

- Move the choke lever to the RUN position.
- Move throttle lever to the  position.
- Pull rope to clear engine of excess fuel. This could require pulling the starter rope many times.

If unit still doesn't start, call 1-800-554-6723.

MAINTENANCE

WARNING: Avoid touching muffler unless engine and muffler are cold. A hot muffler can cause serious burns.

WARNING: Stop engine and be sure the impeller blades have stopped turning before opening the vacuum inlet door or attempting to insert or remove the vacuum or blower tubes. The rotating blades can cause serious injury. Always disconnect the spark plug before performing maintenance or accessing movable parts.

GENERAL RECOMMENDATIONS

The warranty on this unit does not cover items that have been subjected to operator abuse or negligence. To receive full value from the warranty, the operator must maintain unit as instructed in this manual. Various adjustments will need to be made periodically to properly maintain your unit.

CHECK FOR LOOSE FASTENERS AND PARTS

- Spark Plug Boot
- Air Filter
- Housing Screws
- Muffler

CHECK FOR DAMAGED OR WORN PARTS

Contact an authorized service dealer for replacement of damaged or worn parts.

- Fuel Tank - Do not use unit if fuel tank shows signs of damage or leaks.
- Vacuum Bag - Do not use vacuum bag if it is torn or damaged.

INSPECT AND CLEAN UNIT AND DECALS

- After each use, inspect complete unit for loose or damaged parts. Clean the unit and decals using a damp cloth with a mild detergent.
- Wipe off unit with a clean dry cloth.

CLEAN AIR FILTER

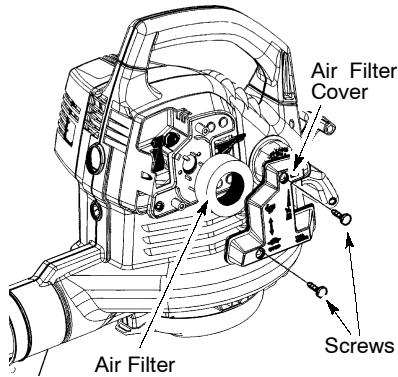

Cleaning the air filter:

A dirty air filter decreases engine performance and increases fuel consumption and harmful emissions. Always clean or replace air filter after every 5 hours of operation or yearly, whichever comes first.

- Clean the cover and the area around it to keep debris from falling into the carburetor chamber when the cover is removed.
- Remove parts as illustrated.

NOTE: Do not clean filter in gasoline or other flammable solvent. Doing so can create a fire hazard or produce harmful evaporative emissions.

- Wash the filter in soap and water.
- Allow filter to dry.
- Apply a few drops of oil to the filter; squeeze filter to distribute oil.
- Replace parts.

REPLACE SPARK PLUG

Replace spark plug each year to ensure the engine starts easier and runs better. Set spark plug gap at 0.025 inch. Ignition timing is fixed, nonadjustable.

- Twist, then pull off spark plug boot.
- Remove spark plug from cylinder and discard.
- Replace with Champion RCJ-6Y spark plug and tighten with a 3/4 in. socket wrench (15 - 20 ft/lbs).
- Reinstall the spark plug boot.

REPLACE FUEL FILTER

To replace fuel filter, drain unit by running it dry of fuel, then remove fuel cap/retainer assembly from tank. Pull filter from tank and remove it from the fuel line. Install new fuel filter on fuel line; reinstall parts.

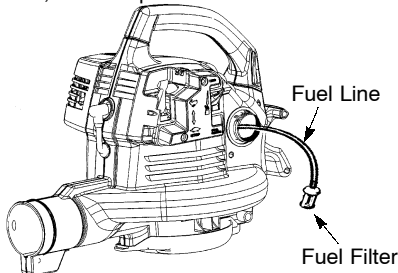

CHECK MUFFLER MOUNTING SCREWS

Once each year, ensure muffler mounting screws are secure and tightened properly to prevent damage.

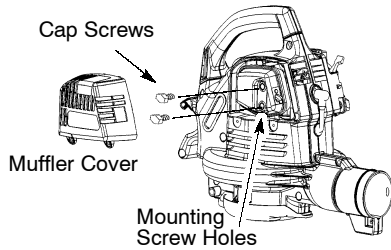

NOTE: The muffler mounting screws are located behind the cap screws. The cap screws must be removed to access the mounting screws.

- Remove muffler cover.
- Loosen and remove the 2 cap screws from the muffler mounting screw holes.
- Tighten the 2 mounting screws (100 in/lbs).
- Reinstall and tighten the 2 cap screws (100 in/lbs).
- Reinstall muffler cover.

INSPECT MUFFLER AND SPARK ARRESTING SCREEN

WARNING: The muffler on this product contains chemicals known to the State of California to cause cancer.

As the unit is used, carbon deposits build up on the muffler and spark arresting screen, and must be removed to avoid creating a fire hazard or affecting engine performance.

TOP VIEW OF MUFFLER

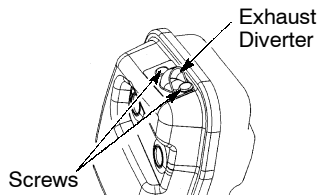

Replace the spark arresting screen every 50 hours of operation or if any damage or breaks in the screen are noted.

NOTE: Do not attempt to clean the spark arresting screen.

- Remove muffler cover.
- Loosen and remove both screws from the exhaust diverter.
- Remove the exhaust diverter and spark arresting screen.
- Install new spark arresting screen.
- Reinstall exhaust diverter and both screws. Tighten screws securely.
- Reinstall muffler cover.

NOTE: If any part of the muffler is cracked, broken or damaged, we recommend that the muffler be replaced.

SERVICE

We recommend all service and adjustments not listed in this manual be performed by an authorized service dealer.

CARBURETOR ADJUSTMENTS

Your carburetor is equipped with limiter caps. Adjusting the carburetor is a complicated task. We recommend that you take your unit to an authorized service dealer. Damage will occur if you turn the needles beyond the limiter stops.

STORAGE

WARNING: Perform the following steps after each use:

- Allow engine to cool, and secure the unit before storing or transporting.
- Store unit and fuel in a well ventilated area where fuel vapors cannot reach sparks or open flames from water heaters, electric motors or switches, furnaces, etc.
- Store unit with all guards in place. Position unit so that any sharp object cannot accidentally cause injury.
- Store unit and fuel well out of the reach of children.

NEED ASSISTANCE?

NEED ASSISTANCE?

Call: 1-800-554-6723.

NEED A SERVICE PART?

Contact your dealer.

TROUBLESHOOTING TABLE

WARNING: Always stop unit and disconnect spark plug before performing any of the recommended remedies below other than remedies that require operation of the unit.

TROUBLE	CAUSE	REMEDY
Engine will not start.	<ul style="list-style-type: none"> • Engine flooded. • Fuel tank empty. • Spark plug not firing. • Fuel not reaching carburetor. 	<ul style="list-style-type: none"> • See "Starting Instructions." • Fill tank with correct fuel mixture. • Install new spark plug. • Check for dirty fuel filter; replace. • Check for kinked or split fuel line; repair or replace. • Contact an authorized service dealer.
Engine will not idle properly.	<ul style="list-style-type: none"> • Fuel not reaching carburetor. • Carburetor requires adjustment. • Crankshaft seals worn. • Compression low. 	<ul style="list-style-type: none"> • Check for dirty fuel filter; replace. • Check for kinked or split fuel line; repair or replace. • See "Carburetor Adjustments." • Contact an authorized service dealer. • Contact an authorized service dealer.
Engine will not accelerate, lacks power, or dies under a load.	<ul style="list-style-type: none"> • Air filter dirty. • Fuel not reaching carburetor. • Spark plug fouled. • Spark arresting screen clogged. • Carburetor requires adjustment. • Carbon build up. • Compression low. 	<ul style="list-style-type: none"> • Clean or replace air filter. • Check for dirty fuel filter; replace. • Check for kinked or split fuel line; repair or replace. • Clean or replace spark plug; re-gap. • Replace screen. • See "Carburetor Adjustments." • Contact an authorized service dealer. • Contact an authorized service dealer.
Engine smokes excessively.	<ul style="list-style-type: none"> • Choke partially on. • Fuel mixture incorrect. • Air filter dirty. • Carburetor requires adjustment. 	<ul style="list-style-type: none"> • Adjust choke. • Empty fuel tank and refill with correct fuel mixture. • Clean or replace air filter. • See "Carburetor Adjustments."
Engine runs hot.	<ul style="list-style-type: none"> • Fuel mixture incorrect. • Spark plug incorrect. • Carburetor requires adjustment. • Carbon build up. 	<ul style="list-style-type: none"> • See "Fueling Your Unit." • Replace with correct spark plug. • See "Carburetor Adjustments." • Contact an authorized service dealer.

LIMITED WARRANTY

ELECTROLUX HOME PRODUCTS, INC., warrants to the original purchaser that each new **Weed Eater** brand gasoline tool or attachment is free from defects in material and workmanship and agrees to repair or replace under this warranty any defective gasoline product or attachment as follows from the original date of purchase

2 YEARS- Parts and Labor, when used for household purposes.

90 DAYS - Parts and Labor, when used for commercial, professional, or income producing purposes.

30 DAYS - Parts and Labor, if used for rental purposes.

This warranty is not transferable and does not cover damage or liability caused by improper handling, improper maintenance, or the use of accessories and/or attachments not specifically recommended by **ELECTROLUX HOME PRODUCTS, INC.**, for this tool. Additionally, this warranty does not cover tune-ups, spark plugs, filters, starter ropes, starter springs, cutting line, or rotating head parts that will wear and require replacement with reasonable use during the warranty period. This warranty does not

cover pre-delivery setup or normal adjustments explained in the instruction manual.

THIS WARRANTY GIVES YOU SPECIFIC LEGAL RIGHTS, AND YOU MAY HAVE OTHER RIGHTS WHICH VARY FROM STATE TO STATE.

NO CLAIMS FOR CONSEQUENTIAL OR OTHER DAMAGES WILL BE ALLOWED, AND THERE ARE NO OTHER EXPRESS WARRANTIES EXCEPT THOSE EXPRESSLY STIPULATED HEREIN.

SOME STATES DO NOT ALLOW LIMITATIONS ON HOW LONG AN IMPLIED WARRANTY LASTS OR THE EXCLUSION OR LIMITATIONS OF INCIDENTAL OR CONSEQUENTIAL DAMAGES, SO THE ABOVE LIMITATIONS OR EXCLUSION MAY NOT APPLY TO YOU.

The policy of **ELECTROLUX HOME PRODUCTS, INC.**, is to continuously improve its products. Therefore, **ELECTROLUX HOME PRODUCTS, INC.**, reserves the right to change, modify, or discontinue models, designs, specifications, and accessories of all products at any time without notice or obligation to any purchaser.

U.S. EPA/CALIFORNIA EMISSION CONTROL WARRANTY STATEMENT

YOUR WARRANTY RIGHTS AND OBLIGATIONS:

The U.S. Environmental Protection Agency/California Air Resources Board and POULAN/WEED EATER, DIVISION OF WCI OUTDOOR PRODUCTS are pleased to explain the emissions control system warranty on your year 2000-2003 small off-road engine. In California, all new small off-road engines must be designed, built, and equipped to meet the State's stringent anti-smog standards. POULAN/WEED EATER must warrant the emission control system on your small off-road engine for the periods of time listed below provided there has been no abuse, neglect, or improper maintenance of your small off-road engine. Your emission control system includes parts such as the carburetor and the ignition system. Where a warrantable condition exists, POULAN/WEED EATER will repair your small off-road engine at no cost to you. Expenses covered under warranty include diagnosis, parts and labor. **MANUFACTURER'S WARRANTY COVERAGE:** If any emissions related part on your engine (as listed under Emissions Control Warranty Parts List) is defective or a defect in the materials or workmanship of the engine causes the failure of such an emission related part, the part will be repaired or replaced by POULAN/WEED EATER. **OWNER'S WARRANTY RESPONSIBILITIES:** As the small off-road engine owner, you are responsible for the performance of the required maintenance listed in your instruction manual. POULAN/WEED EATER recommends that you retain all receipts covering maintenance on your small off-road engine, but POULAN/WEED EATER cannot deny warranty solely for the lack of receipts or for your failure to ensure the performance of all scheduled maintenance. As the small off-road engine owner, you should be aware that POULAN/WEED EATER may deny you warranty coverage if your small off-road engine or a part of it has failed due to abuse, neglect, improper maintenance, unapproved modifications, or the use of parts not made or approved by the original equipment manufacturer. You are responsible for presenting your small off-road engine to a POULAN/WEED EATER authorized repair center as soon as a problem exists. Warranty repairs should be completed in a reasonable amount of time, not to exceed 30 days. If you have any questions regarding your warranty rights and responsibilities, you should contact your nearest authorized service center or call POULAN/WEED EATER at 1-800-554-6723. **WAR-**

RANTY COMMENCEMENT DATE: The warranty period begins on the date the small off-road engine is purchased. **LENGTH OF COVERAGE:** This warranty shall be for a period of two years from the initial date of purchase. **WHAT IS COVERED: REPAIR OR REPLACEMENT OF PARTS.** Repair or replacement of any warranted part will be performed at no charge to the owner at an approved POULAN/WEED EATER servicing center. If you have any questions regarding your warranty rights and responsibilities, you should contact your nearest authorized service center or call POULAN/WEED EATER at 1-800-554-6723. **WARRANTY PERIOD:** Any warranted part which is not scheduled for replacement as required maintenance, or which is scheduled only for regular inspection to the effect of "repair or replace as necessary" shall be warranted for 2 years. Any warranted part which is scheduled for replacement as required maintenance shall be warranted for the period of time up to the first scheduled replacement point for that part. **DIAGNOSIS:** The owner shall not be charged for diagnostic labor which leads to the determination that a warranted part is defective if the diagnostic work is performed at an approved POULAN/WEED EATER servicing center. **CONSEQUENTIAL DAMAGES:** POULAN/WEED EATER may be liable for damages to other engine components caused by the failure of a warranted part still under warranty. **WHAT IS NOT COVERED:** All failures caused by abuse, neglect, or improper maintenance are not covered. **ADD-ON OR MODIFIED PARTS:** The use of add-on or modified parts can be grounds for disallowing a warranty claim. POULAN/WEED EATER is not liable to cover failures of warranted parts caused by the use of add-on or modified parts. **HOW TO FILE A CLAIM:** If you have any questions regarding your warranty rights and responsibilities, you should contact your nearest authorized service center or call POULAN/WEED EATER at 1-800-554-6723. **WHERE TO GET WARRANTY SERVICE:** Warranty services or repairs shall be provided at all POULAN/WEED EATER service centers. call: 1-800-554-6723. **MAINTENANCE, REPLACEMENT AND REPAIR OF EMISSION RELATED PARTS:** Any POULAN/WEED EATER approved replacement part used in the performance of any warranty maintenance or repair on emission related parts will be provided without charge to the owner if the part is under warranty. **EMISSION CONTROL WARRANTY PARTS LIST:** Carburetor, Ignition System: Spark Plug (covered up to maintenance schedule), Ignition Module, Muffler including catalyst. **MAINTENANCE STATEMENT:** The owner is responsible for the performance of all required maintenance as defined in the instruction manual.

This engine is certified to be emissions compliant for the following use:

- Moderate (50 hours)
- Intermediate (125 hours)
- Extended (300 hours)